

PLAN VIEW

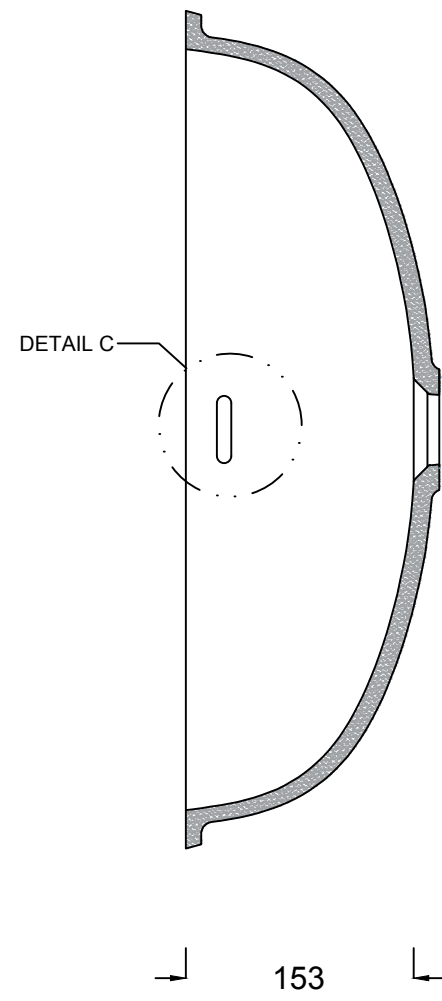

SECTION B:B

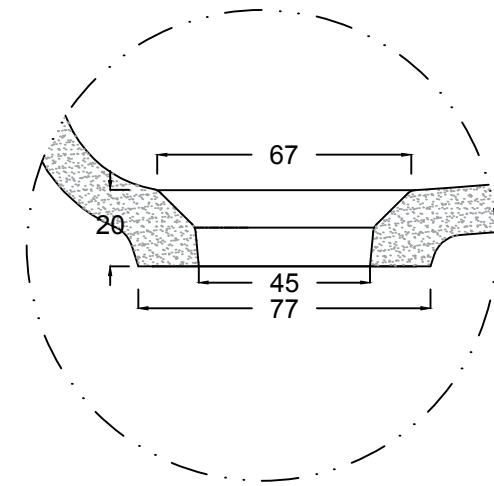

DETAIL A  
SCALE: 1:2

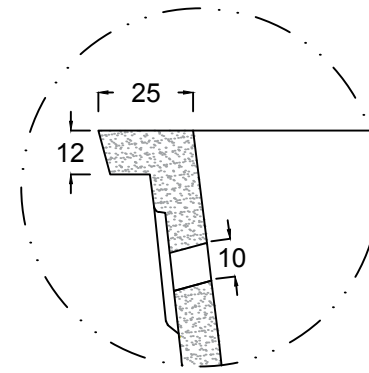

DETAIL B  
SCALE: 1:2

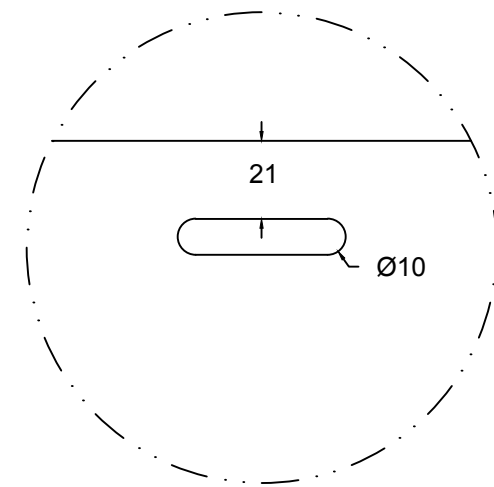

DETAIL C  
SCALE: 1:2

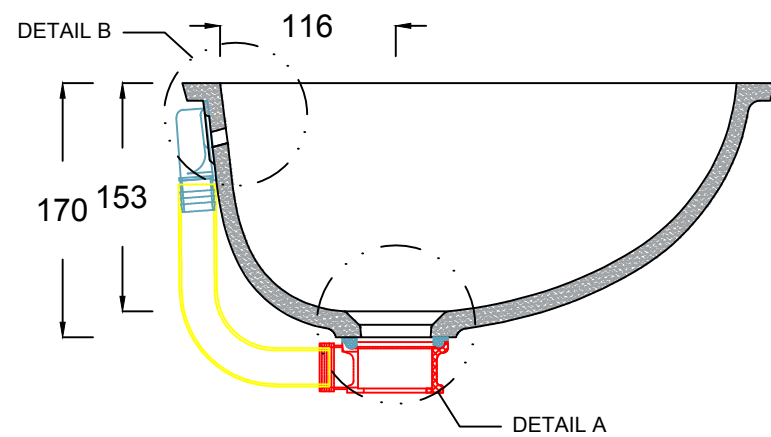

SECTION A:A



Corian.

ARCHIVE NBR: <b>ARCHIVE 3</b>	CUSTOMER NAME:
FILE NAME/FORMAT: DUPONT_CORIAN_CALM831_2D.DWG	APPLICATION/DESCRIPTION: <b>Bath/ Washbasin</b>
MODEL NAME: <b>CALM 831</b>	DOCUMENT STATUS: <b>FINAL</b>
CREATED BY: <b>KS</b>	CODE: <b>D3-831-01</b>
APPROVED BY:	APPROVAL DATE:
LAUNCH DATE:	DATE OF ISSUE: <b>28/05/2015</b>
SCALE: <b>1:5 in A3</b>	REV. NBR/DATE: <b>Rev. 01-14/12/2015</b>

DISCLAIMER/COPYRIGHT:  
THIS DRAWING HAS BEEN FURNISHED BY E.I. DU PONT DE NEMOURS AND COMPANY. THE INFORMATION AND KNOW-HOW THEREON MAY NOT BE USED NOR THE DRAWING REPRODUCED WITHOUT THE WRITTEN PERMISSION OF E.I. DU PONT DE NEMOURS AND COMPANY. ALL REPRODUCTIONS IN WHOLE OR IN PART, INCLUDING VENDOR'S SHOP DRAWINGS, SHALL BEAR OR REFER TO THIS STAMP