

PLAN VIEW

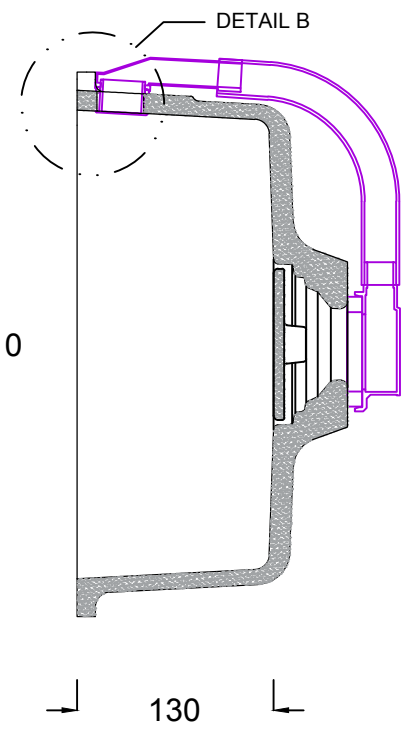

SECTION B:B

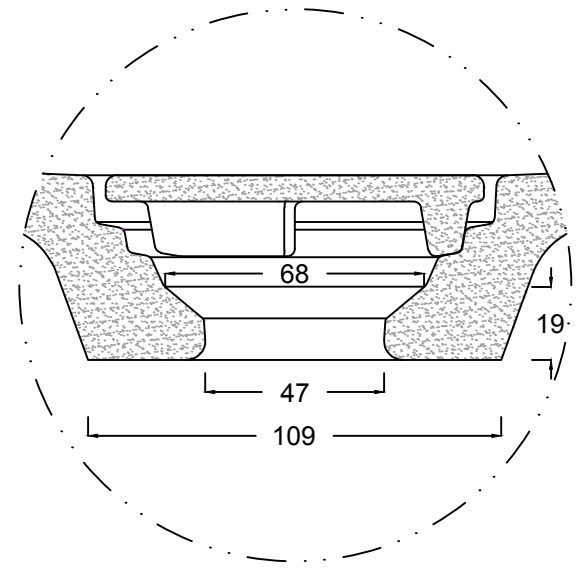

DETAIL A
SCALE: 1:2

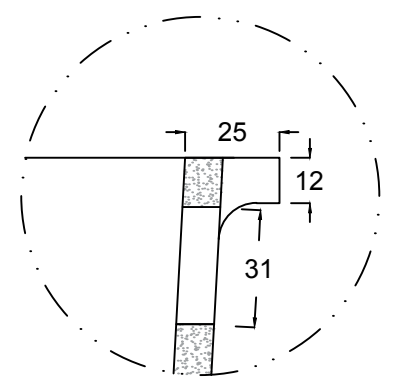

DETAIL B
SCALE: 1:2

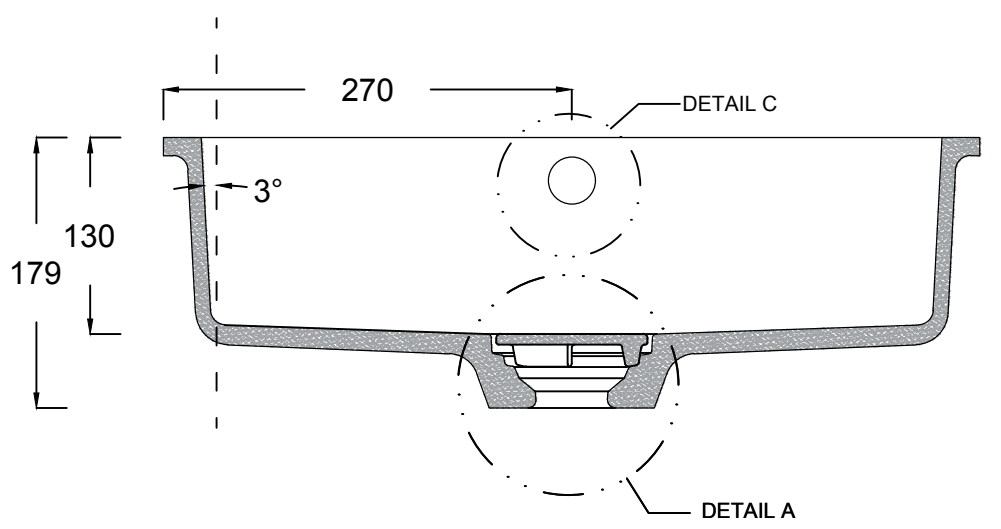

SECTION A:A

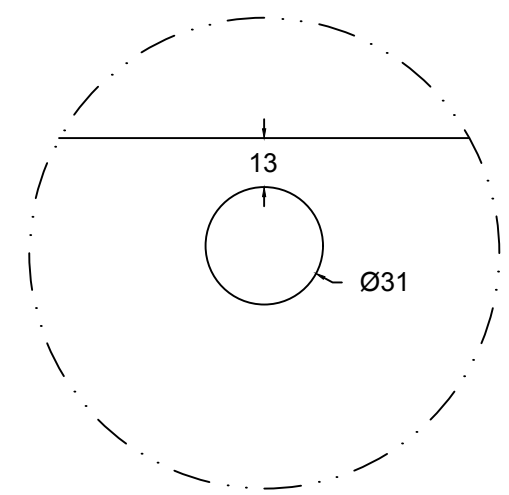

DETAIL C
SCALE: 1:2



Corian.

ARCHIVE NBR: ARCHIVE 3	CUSTOMER NAME:
FILE NAME/FORMAT: DUPONT_CORIAN_ENERGY7720_2D.DWG	APPLICATION/DESCRIPTION: Bath/ Washbasin
MODEL NAME: ENERGY 7720	DOCUMENT STATUS: FINAL
CREATED BY: KS	CODE: D3-7720-02
APPROVED BY:	APPROVAL DATE:
LAUNCH DATE:	DATE OF ISSUE: 28/05/2015
SCALE: 1:5 in A3	REV. NBR/DATE: Rev. 01-14/12/2015

DISCLAIMER/COPYRIGHT:
THIS DRAWING HAS BEEN FURNISHED BY E.I. DU PONT DE NEMOURS AND COMPANY. THE INFORMATION AND KNOW-HOW THEREON MAY NOT BE USED NOR THE DRAWING REPRODUCED WITHOUT THE WRITTEN PERMISSION OF E.I. DU PONT DE NEMOURS AND COMPANY. ALL REPRODUCTIONS IN WHOLE OR IN PART, INCLUDING VENDOR'S SHOP DRAWINGS, SHALL BEAR OR REFER TO THIS STAMP